

TRIPLE BUNK ASSEMBLY INSTRUCTION
IMPORTANT-READ CAREFULLY-RETAIN FOR FUTURE REFERENCE

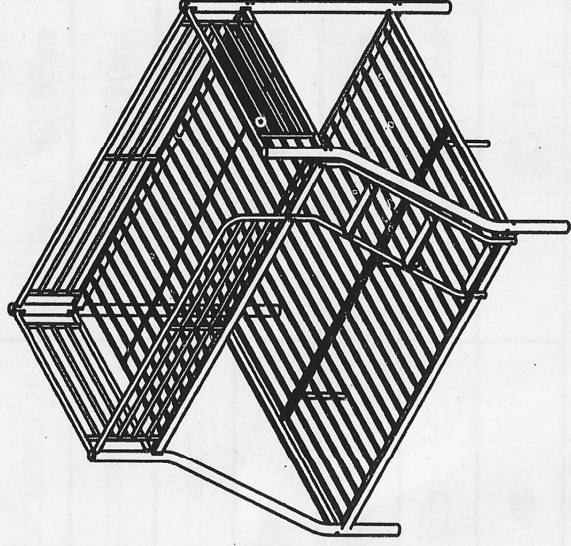















SAFETY WARNING

- All bunk beds and high beds intended to be assembled by someone other than the manufacturer or their representative shall contain assembly instructions a list of the parts supplied and details of any tools required to assemble the bed;
- We recommend that you use the mattress at size:1900*900*160mm.
- All assembly fastenings should always be tightened properly and that care should be taken that no fittings are loose.
- Instructions regarding positioning and connection of the means of access;
- The ladder is not for playing on, only use to climb onto top bunk.
- We recommend only one person on the upper bunk at one time.
- Warning:**-The bunk bed or high bed should not be used if any structural part is broken or missing.
- The top of the mattress shall be at least 160MM below the upper edge of the safety barriers.
- Warning:**Children can become trapped between the bed and the wall
To avoid risk of serious injury the distance between the top safety barrier and the wall shall not exceed 75mm or shall be more than 230mm”.
- Warning:** “High beds and upper level of the bunk beds are not suitable for children under six years due to the risk of injury from falls.”
- Warning:** “Bunk beds and high beds can present a serious risk of injury from strangulation if not used correctly. Never attach or hang items to any part of the bunk bed that are not designed to be used with the bed, for example, but not limited to ropes, strings, cords, hooks, belts and bags.
- The ventilation of the room is necessary in order to keep the humidity low and to prevent mold in and around the bed
- The manufacturer’s instruction must be always followed

-EN 747-1&2:2012+A1:2015 TEST version

PLEASE CHECK THAT YOU HAVE ALL THE PARTS LISTED BEFORE YOU START ASSEMBLY. IF YOU DO FIND THAT SOMETHING IS MISSING, PLEASE CONTACT YOUR SUPPLIER IMMEDIATELY

REF		HARDWARE LIST	QTY
a		BOLT M8X65mm	16PCS
b		BOLT M6X70mm	3PCS
c		BOLT M6X85mm	4PCS
d		BOLT M6X15mm	20PCS
e		BOLT M6X40mm	3PCS
f		BOLT M6X17mm	16PCS
g		NUT M6	3PCS
h		WASHER ø8.2	16PCS
i		WASHER ø6.5	3PCS
j		BOLT M6X35mm	4PCS
k		BOLT M6X55mm	6PCS
l		SPANNER	1PC
m		ALLEN KEY M5	1PC
n		ALLEN KEY M4	1PCS

CARE & MAINTENANCE

- 1) No power tools shall be used for assembly of the bed . Use only allen keys provided for assembly.
- 2) Periodically check and ensure all are fully tightened.













Method of Cleaning

- 1) Use damp cloth for normal cleaning.
- 2) For bright parts, use a clean dry duster only.

USE OF POWER TOOLS TO ASSEMBLE THIS PRODUCT WILL INVALIDATE ANY CLAIM AND MAY DAMAGE THIS PRODUCT, MAKING IT UNSAFE.



PLEASE CHECK THAT YOU HAVE ALL THE PARTS LISTED BEFORE YOU START ASSEMBLY. IF YOU DO FIND THAT SOMETHING IS MISSING. PLEASE CONTACT YOUR SUPPLIER IMMEDIATELY

REF		PART LIST	QTY
①		BACK POST TUBE	2PC
②		LEFT POST TUBE	1PC
③		RIGHT POST TUBE	1PC
④		SIDE FRAME (HEAD BOARD&FOOT BOARD)	2PC
⑤		SUPPORT BAR	2PC
⑥		MATTRESS FRAME (TOP)	1PC
⑦		MATTRESS FRAME (BOTTOM)	1PC
⑧		FRONT GUARD RAIL	1PC
⑨		BACK GUARD RAIL	1PC
⑩		LEFT STEPS TUBE	1PC
⑪		RIGHT STEPS TUBE	1PC
⑫		STEPS PEDAL	3PC
⑬		CENTER SUPPORT LEG	3PC

CARE & MAINTENANCE

- 1) No power tools shall be used for assembly of the bed. Use only allen keys provided for assembly.
- 2) Periodically check and ensure all are fully tightened.

Method of Cleaning

- 1) Use damp cloth for normal cleaning.
- 2) For bright parts, use a clean dry duster only.

USE OF POWER TOOLS TO ASSEMBLE THIS PRODUCT WILL INVALIDATE ANY CLAIM AND MAY DAMAGE THIS PRODUCT, MAKING IT UNSAFE.



Assembly Steps:

Step 1

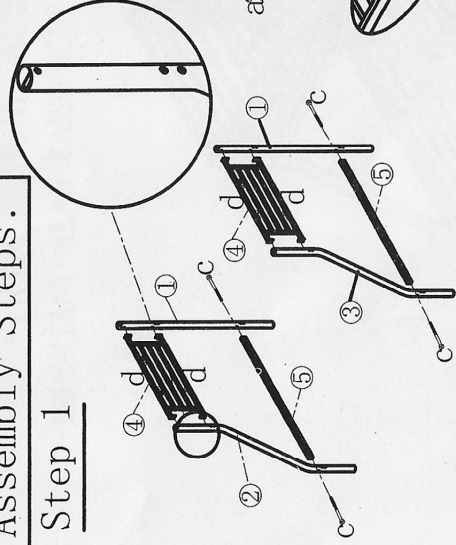

Step 2

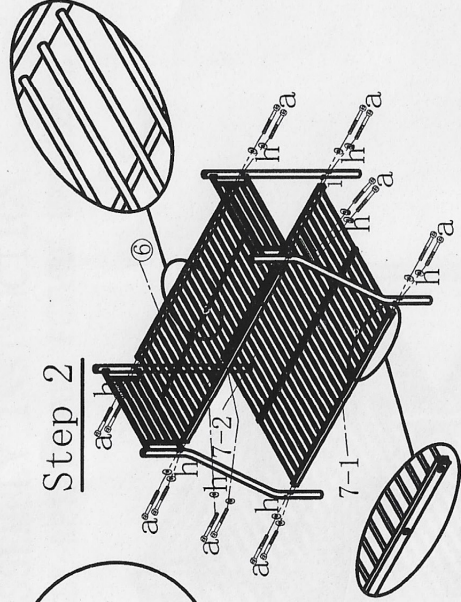

Step 3

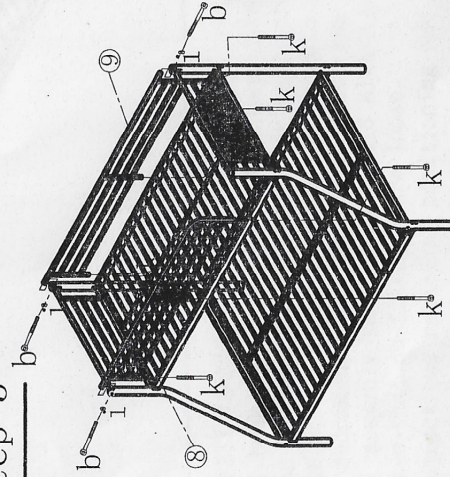

Step 4

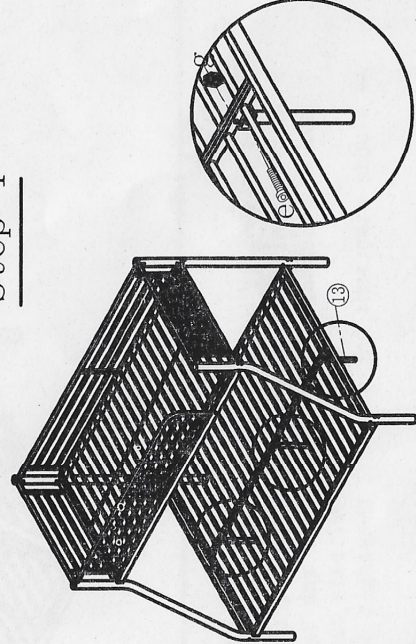

Step 5

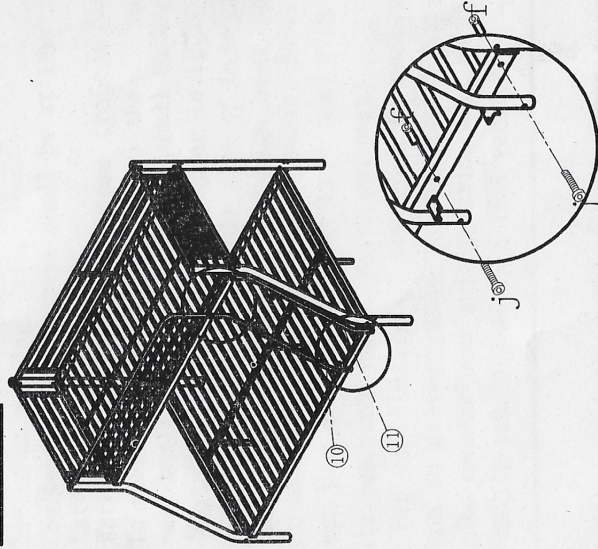

Step 6

