

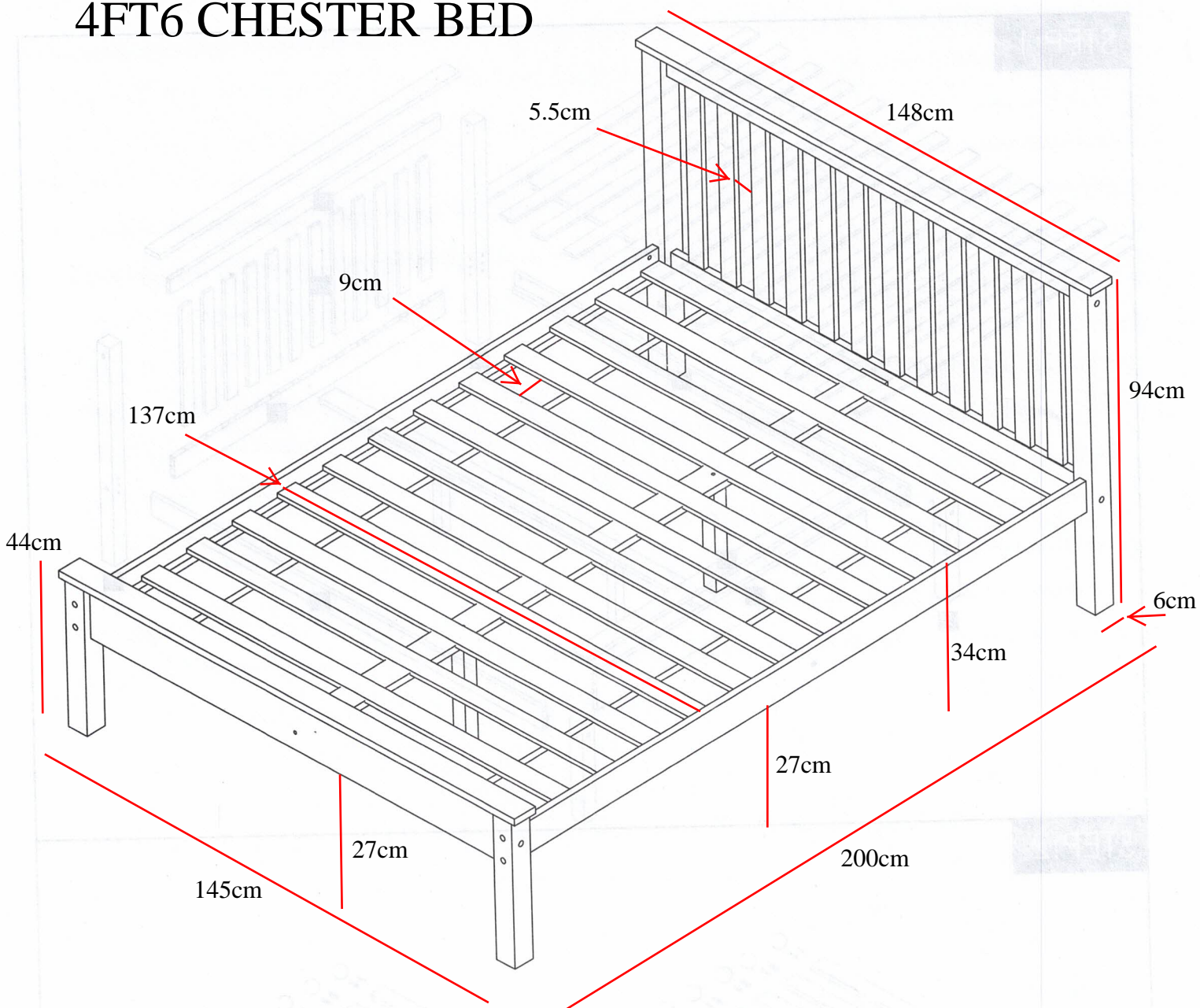









# 4FT6 CHESTER BED

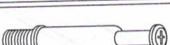

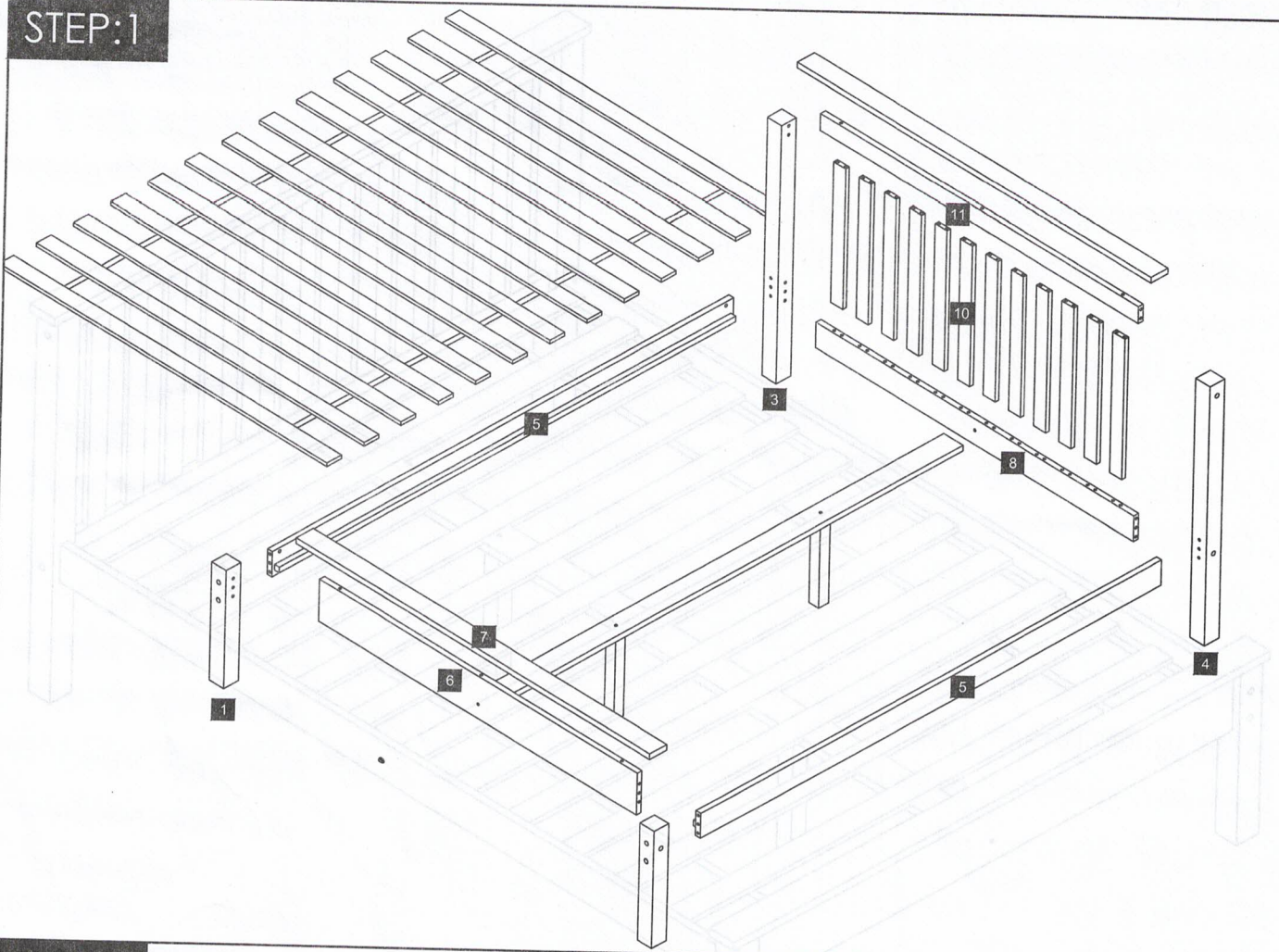

A		M6*90	14
B			14
C		Φ8*30	62
D		1510	6
E			6
F		Φ7*50	4
G		4*30	26
H		Φ15	14
J		Φ12	2
K		4 mm	1

**STEP:1**

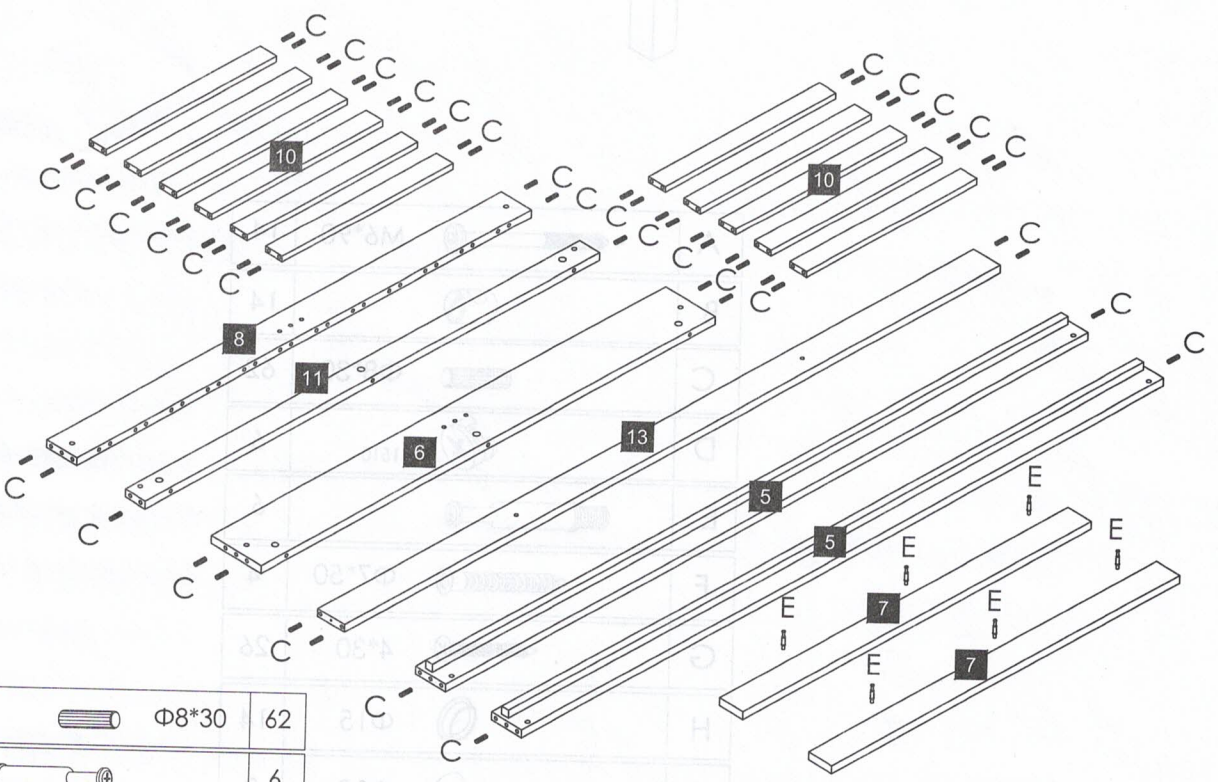

**STEP:2**

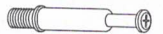

C		Φ8*30	62
E			6

# STEP:3

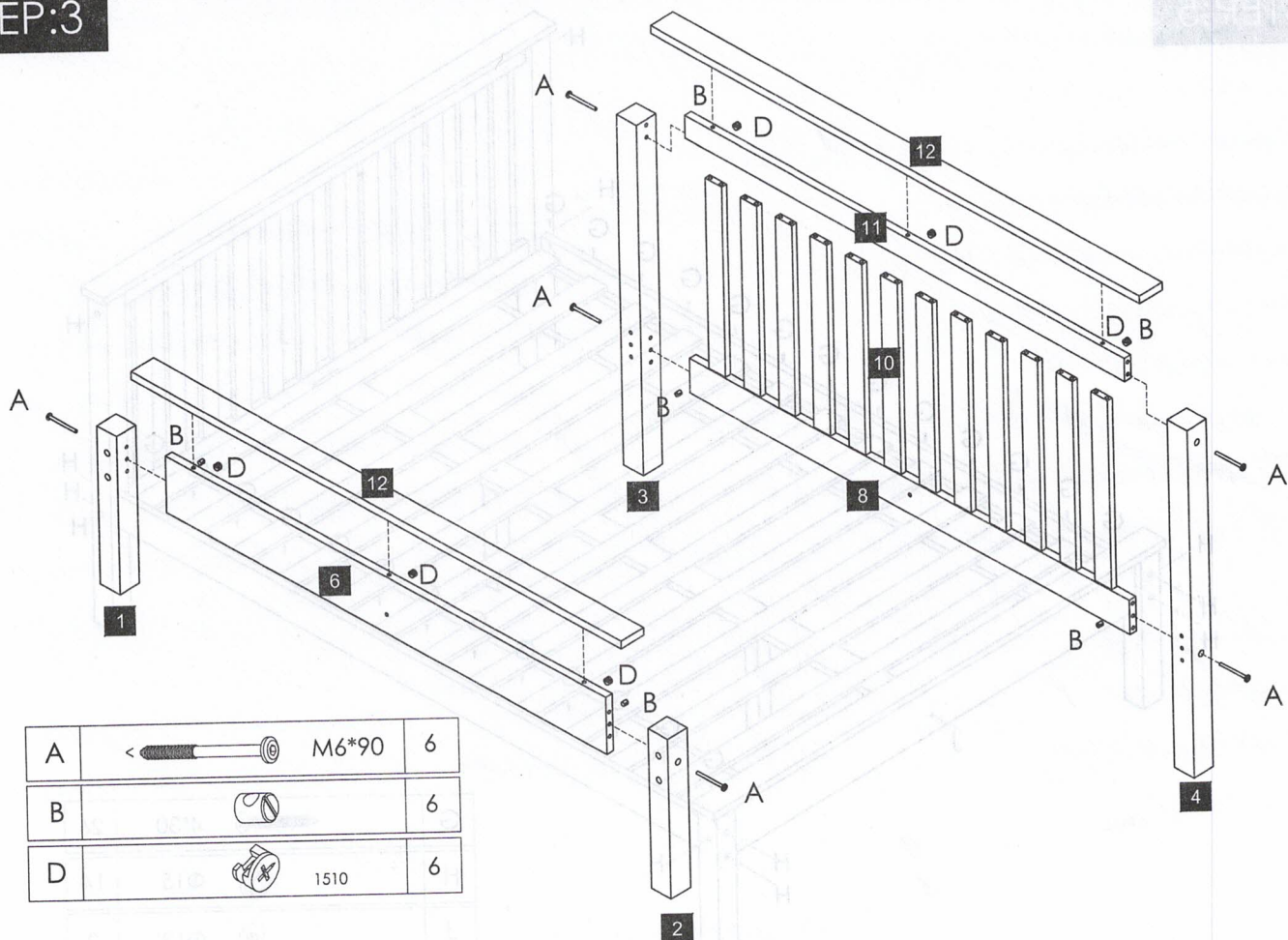



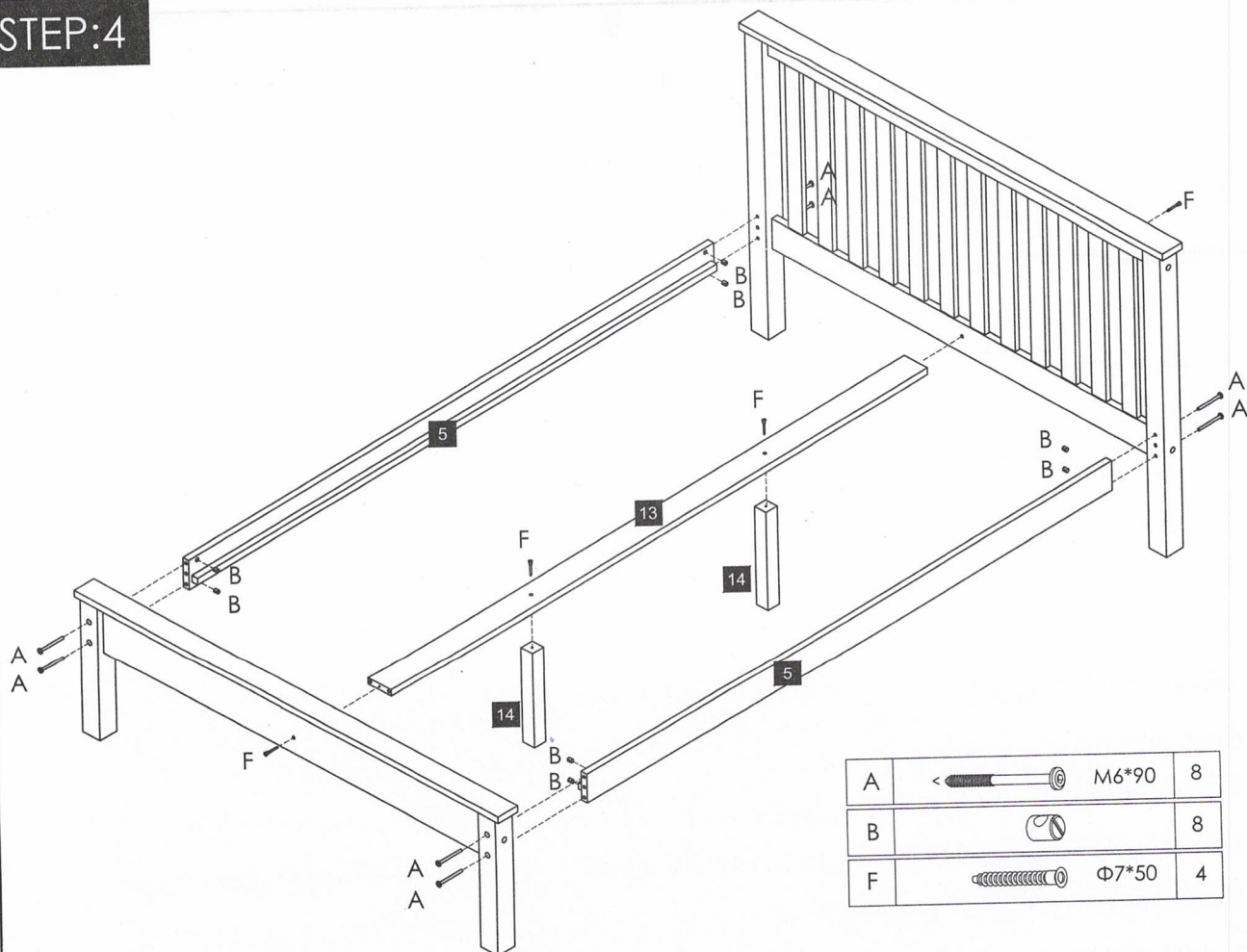

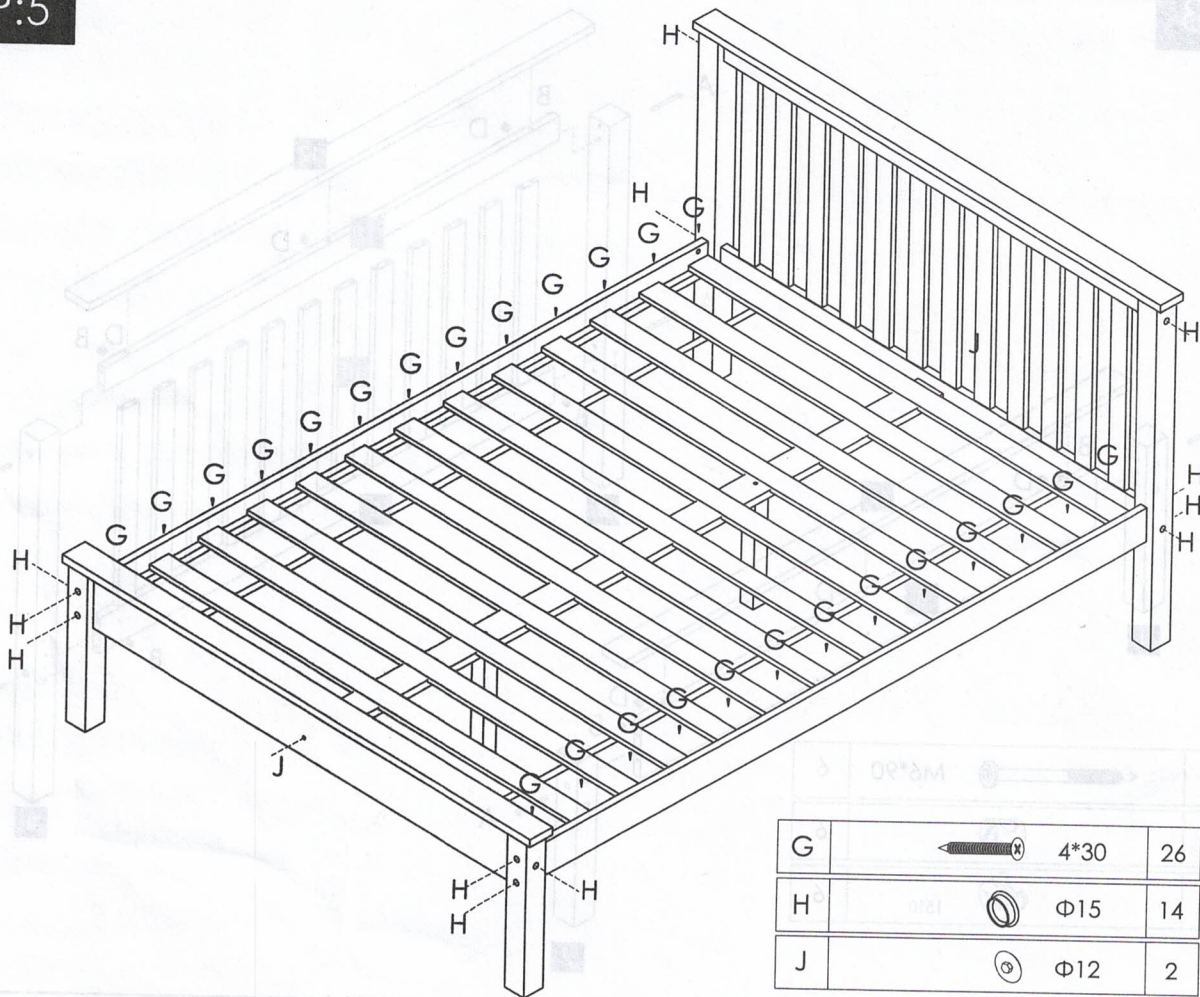

# STEP:4



# STEP:5



G		4*30	26
H		Φ15	14
J		Φ12	2

B		4*30	A
B		Φ15	B
A		Φ12	F